

SECTION B-B

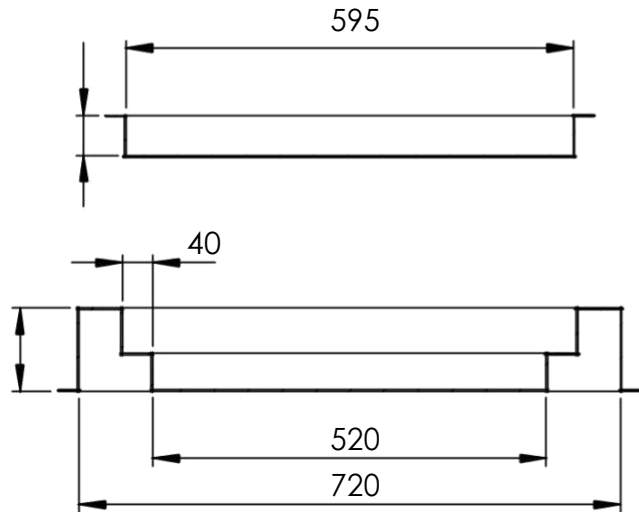

SECTION A-A

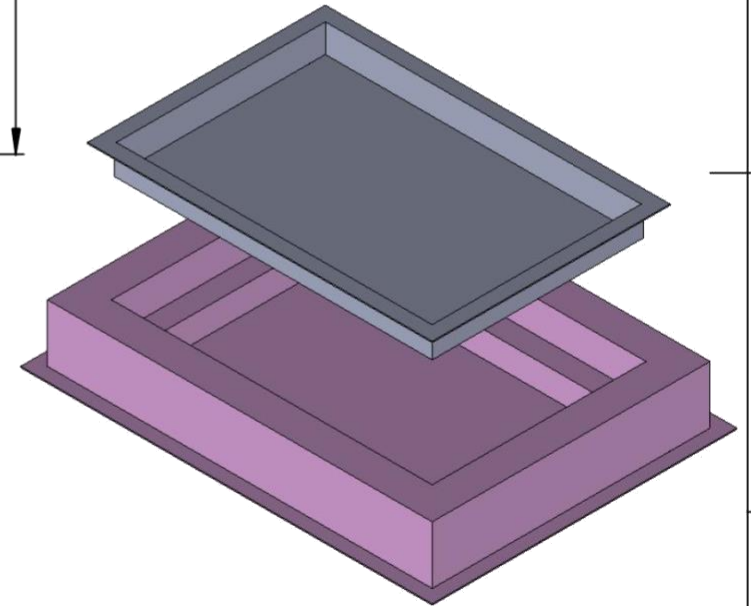

DESCRIPTION: Man Hole Cover 520 X 320		
DWG NO: DRSTI-PC-27	MATERIAL: Concrete	PRODUCT CODE: MH004
DRSTI PRECAST PRIVATE LTD		A4